

PE-64/304 Pendant Speaker System

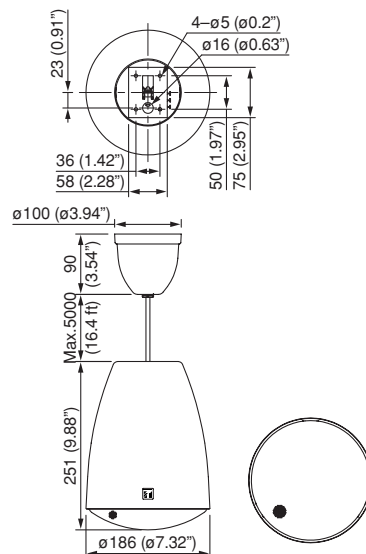

APPEARANCE AND DIMENSIONAL DIAGRAM



DESCRIPTION

The PE-64/304 are HIPS resin bass-reflex enclosure 5" (12cm) cone-type pendant speakers intended for ceiling suspension installation. The PE-304 also includes a balanced dome tweeter. They have an outstandingly stylish design that is inspired by the finest lighting fixtures, allowing them to harmoniously blend in with lighting equipment. They are ideally suited for such applications as BGM and announcements at high-ceiling venues such as airports, factories and shopping malls. The speakers are easy to repaint, extending the range of design needs they can meet. A directly attached sturdy suspension cable is extendable up to 5 meters. PE-64 is driven on a high-impedance (100V or 70V) line, and PE-304 is driven on a high- and low-impedance(8Ω) line. Input impedance is adjustable with rotary switch on the upper side of the speaker.

FEATURES

- Stylish and outstanding design inspired by the finest lighting fixtures
- Sturdy cable extendable up to 5 meters
- Repaintable
- Input impedance easily changeable
- Ideally suited for BGM and announcements

Wiring Diagram

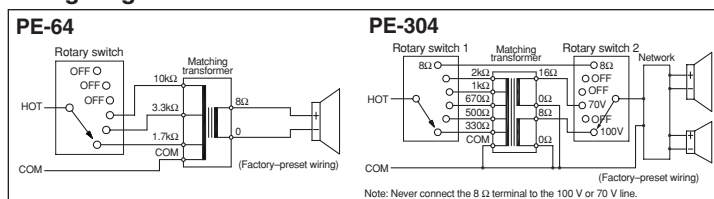

SPECIFICATIONS

PE-64

Enclosure:	Bass-reflex type
Rated Input:	6W (100V line), 3W (70V line)
Rated Impedance:	100V line: 1.7kΩ (6W), 3.3kΩ (3W), 10 kΩ(1W) 70V line: 1.7kΩ (3W), 3.3kΩ (1.5W), 10 kΩ (0.5W)
Sensitivity (1W, 1m):	90dB (500 – 5,000Hz, pink noise)
Frequency Response:	100 – 18,000Hz (peak -20dB)
Speaker Component:	5" (12cm) cone-type
Speaker Cord:	2-core cabtyre cord 5m (16.4 ft)
Applicable Cable:	600V vinyl-insulated cable (IV wire or HIV wire) Solid copper wire: ø0.8 – ø1.6mm (equivalent to AWG 20 – 14) 7-core twisted copper wire: 0.75 – 1.25mm ² (equivalent to AWG 18 – 16)
Connction:	Push-in connector (bridging terminal-2 branch type)
Finish:	Enclosure: HIPS resin, off-white (RAL 9010 or equivalent colour) Grille: Surface-treated steel plate net, off-white (RAL 9010 or equivalent colour), paint
Dimensions:	ø186 × 251(H) mm (ø7.32" × 9.88") (unit only)
Weight:	1.5kg (3.31 lb) (unit only)
Accessory:	Ceiling bracket × 1, Mounting hanger × 1, Ceiling cover × 1, Speaker mounting screw (4 × 16) × 4

PE-304

Enclosure:	Bass-reflex type
Rated Input:	30W (100V), 70V line, 8Ω
Rated Impedance:	100V line: 330Ω (30W), 500Ω (20W), 670Ω (15W), 1kΩ (10W), 2kΩ (5W) 70V line: 170Ω (30W), 250Ω (20W), 330Ω (15W), 500Ω (10W), 1 kΩ (5W) 8Ω (30W)
Sensitivity (1W, 1m):	91dB (500 – 5,000Hz, pink noise)
Frequency Response:	70 – 20,000Hz (peak -20dB)
Speaker Component:	5" (12cm) cone-type + balanced dome tweeter
Speaker Cord:	2-core cabtyre cord 5m (16.4 ft)
Applicable Cable:	600V vinyl-insulated cable (IV wire or HIV wire) Solid copper wire: ø0.8 – ø1.6mm (equivalent to AWG 20 – 14) 7-core twisted copper wire: 0.75 – 1.25mm ² (equivalent to AWG 18 – 16)
Connction:	Push-in connector (bridging terminal-2 branch type)
Finish:	Enclosure: HIPS resin, off-white (RAL 9010 or equivalent colour) Grille: Surface-treated steel plate net, off-white (RAL 9010 or equivalent colour), paint
Dimensions:	ø186 × 251(H) mm (ø7.32" × 9.88") (unit only)
Weight:	2.1kg (4.63 lb) (unit only)
Accessory:	Ceiling bracket × 1, Mounting hanger × 1, Ceiling cover × 1, Speaker mounting screw (4 × 16) × 4

Polar Response

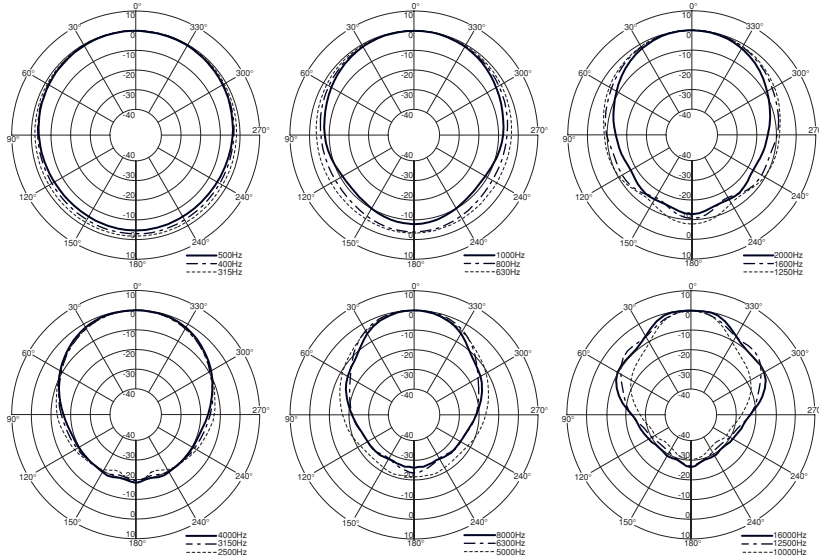

SPL vs. Frequency

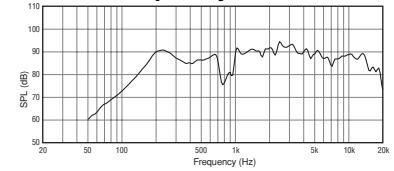

Beamwidth vs. Frequency

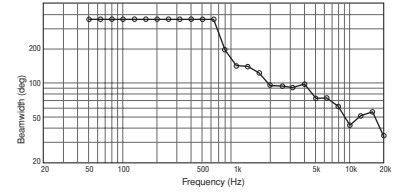

Directivity Factor vs. Frequency

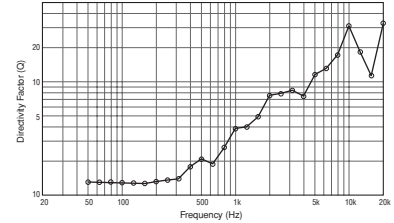

PE-304

Polar Response

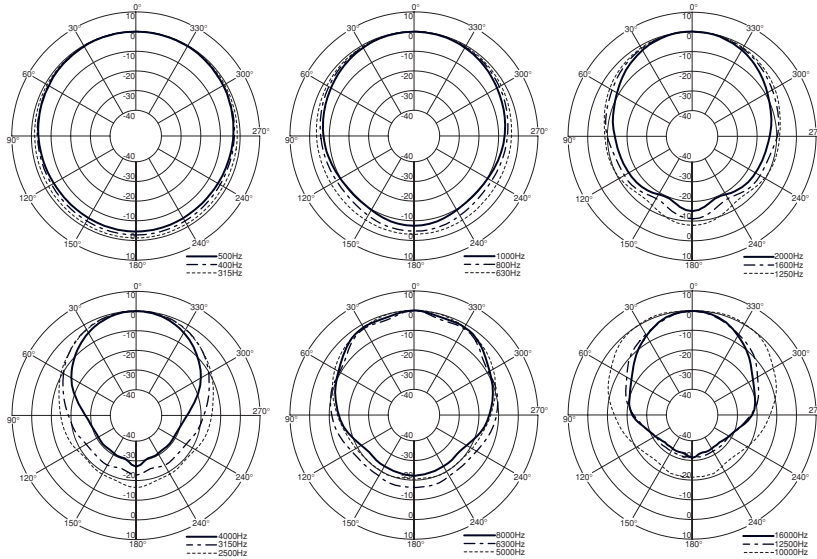

SPL vs. Frequency

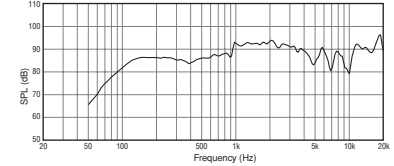

Beamwidth vs. Frequency

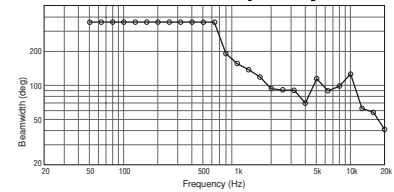

Directivity Factor vs. Frequency

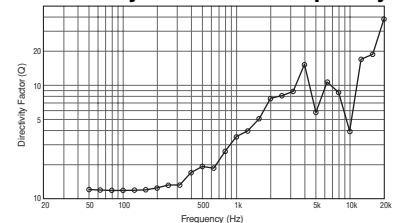

Architect's and Engineer's Specifications

PE-64

The speaker shall be a bass-reflex 5" (12cm) cone type suitable for ceiling suspension mounting. Input impedance shall be easily adjustable with rotary switch on the upper side of the speaker.

The speaker shall include a transformer having multiple taps (1W, 3W, 6W at 100V and 0.5W, 1.5W, 3W at 70V) adjustable. The output sound pressure level at a distance of 1m with a 1W input level applied shall be 90 dB SPL. The speaker shall have a frequency response of 100 – 18,000Hz (-20dB).

The speaker enclosure shall be constructed of HIPS resin. The grille shall be constructed of surface-treated steel plate net. The speaker shall be available in off-white colour, and shall be easily repaintable. The unit shall have dimensions of $\phi 186 \times 251$ (H) mm ($\phi 7.32" \times 9.88"$), and a weight of 1.5 kg (3.31 lb).

The speaker shall be a TOA model PE-64.

PE-304

The speaker shall be a bass-reflex 5" (12cm) cone type, plus balanced dome tweeter, suitable for ceiling suspension mounting. Input impedance shall be easily adjustable with rotary switch on the upper side of the speaker.

The speaker shall include a transformer having multiple taps (5W, 10W, 15W, 20W, 30W at 100V and 70V, and 8 Ω) adjustable. The output sound pressure level at a distance of 1m with a 1W input level applied shall be 91 dB SPL. The speaker shall have a frequency response of 70 – 20,000Hz (-20dB).

The speaker enclosure shall be constructed of HIPS resin. The grille shall be constructed of surface-treated steel plate net. The speaker shall be available in off-white colour, and shall be easily repaintable. The unit shall have dimensions of $\phi 186 \times 251$ (H) mm ($\phi 7.32" \times 9.88"$), and a weight of 2.1 kg (4.63 lb).

The speaker shall be a TOA model PE-304.