

Panasonic®

Installation Manual

DECT Repeater
Model No. **KX-A406**



Thank you for purchasing this Panasonic product.
Please read this manual carefully before using this product and save this manual for future use.

Note

- In this manual, the suffix of each model number is omitted unless necessary.

Document Version: 2015-02

Introduction

Outline

This manual describes information about the installation and registration of KX-A406.

Related Documentation

- **Quick Start Guide**

Describes setup and safety information of the unit.

Manuals and supporting information are provided on the Panasonic Web site at:
<http://panasonic.net/pcc/support/pbx/>

Note

The contents and design of the software are subject to change without notice.

About this Installation Manual

This Installation Manual is designed to serve as an overall installation reference when using this repeater with Panasonic Cell Stations/Portable Stations, Panasonic SIP Cordless Phones, and Panasonic Digital Cordless Phones.

The SIP Cordless Phone base unit and the Digital Cordless Phone base unit are described as base unit in this manual.

This manual contains the following sections:

1. Linking to Cell Stations

Details the procedure for using the repeater with Panasonic Cell Stations and Portable Stations.

2. Linking to SIP Cordless Phones

Details the procedure for using the repeater with Panasonic SIP Cordless Phones.

3. Linking to Digital Cordless Phones

Details the procedure for using the repeater with Panasonic Digital Cordless Phones.

Important Information

Important Information4
 For best performance7

Overview

Overview9
 System Connection Example9
 Location of Controls11
 Included Accessories11

1. Linking to Cell Stations

Linking to Cell Stations12
 Compatible Devices12
 Indicators12
 Procedure Overview15
 Registering the Repeater16
 Using the Repeater18
 Troubleshooting19

2. Linking to SIP Cordless Phones

Linking to SIP Cordless Phones22
 Compatible Devices22
 Indicators22
 Installation/Registering the Repeater23
 Troubleshooting24

3. Linking to Digital Cordless Phones

Linking to Digital Cordless Phones (except for
 North America)26
 Indicators26
 Installation/Registering the Repeater26
 Troubleshooting28

Appendix

Appendix29
 Wall Mounting29
 Specifications31

Important Information

CAUTION

SECURITY REQUIREMENTS

Preventing Data Disclosure Over the Network

- To ensure the security of private conversations, only connect the product to a secure network.
 - To prevent unauthorized access, only connect the product to a network that is properly managed.
-

Note

SAFETY REQUIREMENTS

- Before connecting the product, confirm that the product supports the intended operating environment.
- If the product does not operate properly, disconnect the AC adaptor cord, then connect again.
- The product may not operate in the event of a power failure.
- Satisfactory operation, interoperability, and compatibility cannot be guaranteed with all equipment connected to the product, nor with all services provided by telecommunications providers over networks connected to the product.

SECURITY REQUIREMENTS

- Privacy of communications may not be ensured when using the wireless systems.

Information for Users on Collection and Disposal of Old Equipment and used Batteries



These symbols on the products, packaging, and/or accompanying documents mean that used electrical and electronic products and batteries should not be mixed with general household waste.

For proper treatment, recovery and recycling of old products and used batteries, please take them to applicable collection points, in accordance with your national legislation and the Directives 2002/96/EC and 2006/66/EC.

By disposing of these products and batteries correctly, you will help to save valuable resources and prevent any potential negative effects on human health and the environment which could otherwise arise from inappropriate waste handling.

For more information about collection and recycling of old products and batteries, please contact your local municipality, your waste disposal service or the point of sale where you purchased the items.

Penalties may be applicable for incorrect disposal of this waste, in accordance with national legislation.

For business users in the European Union

If you wish to discard electrical and electronic equipment, please contact your dealer or supplier for further information.

Information on Disposal in other Countries outside the European Union

These symbols are only valid in the European Union. If you wish to discard these items, please contact your local authorities or dealer and ask for the correct method of disposal.



Cd

Note for the battery symbol (bottom two symbol examples):

This symbol might be used in combination with a chemical symbol. In this case it complies with the requirement set by the Directive for the chemical involved.

Important Information

For Users in European countries

The following declaration is applicable to KX-A406CE/KX-A406UK only

CE 0470

Panasonic System Networks Co., Ltd. declares that this equipment is in compliance with the essential requirements and other relevant provisions of Radio & Telecommunications Terminal Equipment (R&TTE) Directive 1999/5/EC.

Declarations of Conformity for the relevant Panasonic products described in this manual are available for download by visiting:

<http://www.ptc.panasonic.eu>

Contact to Authorized Representative:

Panasonic Testing Center

Panasonic Marketing Europe GmbH

Winsbergring 15, 22525 Hamburg, Germany

Ecodesign information

Ecodesign information under EU Regulation (EC) No.1275/2008 amended by (EU) Regulation No. 801/2013.

=====

Please visit here: www.ptc.panasonic.eu

click [Downloads]

→ Energy related products information (Public)

=====

Power consumption in networked standby and guidance are mentioned in the web site above.

For Users in the United States Only

FCC and Other Information

Privacy of communications may not be ensured when using this product.

FCC RF Exposure Warning

- This product complies with FCC radiation exposure limits set forth for an uncontrolled environment.
- To comply with FCC RF exposure requirements, the product must be installed and operated 20 cm (8 inches) or more between the product and all person's body.
- This product may not be collocated or operated in conjunction with any other antenna or transmitter.

FCC ID can be found on the back of this product.

Note

This equipment has been tested and found to comply with the limits for a Class B digital device, pursuant to Part 15 of the FCC Rules. These limits are designed to provide reasonable protection against harmful interference in a residential installation. This equipment generates, uses, and can radiate radio frequency energy and, if not installed and used in accordance with the instructions, may cause harmful interference to radio communications. However, there is no guarantee that interference will not occur in a particular installation. If this equipment does cause harmful interference to radio or television reception, which can be determined by turning the equipment off and on, the user is encouraged to try to correct the interference by one or more of the following measures:

- Reorient or relocate the receiving antenna.
- Increase the distance between the equipment and receiver.

- Connect the equipment to an outlet on a circuit different from that to which the receiver is connected.
- Consult the dealer or an experienced radio/TV technician for help.

This device complies with Part 15 of the FCC Rules. Operation is subject to the following two conditions: (1) this device may not cause harmful interference, and (2) this device must accept any interference received, including interference that may cause undesired operation.

CAUTION

Any changes or modifications not expressly approved by the party responsible for compliance could void the user's authority to operate this product.

For Users in Canada Only

Industry Canada Notices and Other Information

This product meets the applicable Industry Canada technical specifications.

Note

This device complies with Industry Canada licence-exempt RSS standard(s). Operation is subject to the following two conditions: (1) this device may not cause interference, and (2) this device must accept any interference, including interference that may cause undesired operation of the device.

Privacy of communications may not be ensured when using this product. Some wireless telephones operate at frequencies that may cause interference to nearby TVs and VCRs. To minimize or prevent such interference, the base of the wireless telephone should not be placed near, or on top of, a TV or VCR.

This will often reduce, or eliminate, interference.

This Class B digital apparatus complies with Canadian ICES-003.

CAUTION

Any changes or modifications not expressly approved by the party responsible for compliance could void the user's authority to operate this product.

RF Exposure Warning

- This product complies with IC radiation exposure limits set forth for an uncontrolled environment.
 - To comply with IC RF exposure requirements, the product must be installed and operated 20 cm (8 inches) or more between the product and all person's body.
 - This product may not be collocated or operated in conjunction with any other antenna or transmitter.
-

For best performance

Repeater location/avoiding noise

The repeater and other compatible Panasonic products use radio waves to communicate with each other.

- For maximum coverage and noise-free communications, place your repeater:
 - at a convenient, high, and central location with no obstructions between the PS/handset and repeater in an indoor environment.
 - away from electronic appliances such as TVs, radios, personal computers, wireless devices, or other phones.
 - facing away from radio frequency transmitters, such as external antennas of mobile phone cell stations. (Avoid putting the repeater on a bay window or near a window.)
 - Coverage and voice quality depends on the local environmental conditions.
 - If the reception for a repeater location is not satisfactory, move the repeater to another location for better reception.
-

Important Information

Environment

- Keep the repeater away from electrical noise generating devices, such as fluorescent lamps and motors.
- The repeater should be kept free from excessive smoke, dust, high temperature, and vibration.
- The repeater should not be exposed to direct sunlight.
- Do not place heavy objects on top of the repeater.
- When you leave the repeater unused for a long period of time, unplug the repeater from the AC outlet.
- The repeater should be kept away from heat sources such as radiators, cookers, etc. It should not be placed in rooms where the temperature is less than 0 °C (32 °F) or greater than 40 °C (104 °F). Damp basements should also be avoided.
- The maximum calling distance may be shortened when the repeater is used in the following places:
Near obstacles such as hills, tunnels, underground, near metal objects such as wire fences, etc.
- Operating the repeater near electrical appliances may cause interference. Move away from the electrical appliances.
- To prevent malfunction, deformity, overheating, rust, and discolouration, do not install or place equipment in the following types of locations:
 - Locations where air ventilation is poor.
 - Locations that may be exposed to sulphurous gas, such as near hot springs.
 - Near devices that emit heat, such as heaters.
 - Near devices that emit electromagnetic noise, such as radios or televisions.
 - Near devices that emit high-frequency noise, such as sewing machines or welders.

Routine care

- **Wipe the outer surface of the repeater with a soft moist cloth.**
- Do not use benzine, thinner, or any abrasive powder.
- Disconnect the AC adaptor cord from the product before cleaning. Clean the product with a soft, dry cloth. Do not use liquid, aerosol cleaners, abrasive powders, or chemical agents to clean the product.

Placement

- Install the repeater within CS/base unit range in an indoor environment. We recommend installing the repeater in a raised position (such as on a wall).
- Avoid positioning the repeater close to objects that will interfere with reception, such as thick walls, radiators, metal shelving, etc.
- For maximum distance noise-free operation, place the repeater away from electrical appliances such as TV, radio, personal computer, or other telephone equipment.
- Keep an appropriate distance from the CS/base unit to maximize the range of your phone system. Find the appropriate location by checking the RSSI*¹/ID indicator. If the RSSI/ID indicator turns red or amber, re-position the repeater in a place where the RSSI/ID indicator turns green. For details about the RSSI/ID indicator, refer to the following pages.
When using the repeater with
 - Cell Stations: refer to "Indicators (Page 12)",
 - SIP Cordless Phones: refer to "Indicators (Page 22)", and
 - Digital Cordless Phones: refer to "Indicators (Page 26)".

*1 RSSI: Received Signal Strength Indication

Overview

A repeater is used when you need to extend the range of a handset or a DECT Portable Station (PS) or a SIP/Digital handset to include areas where reception was previously not available. The repeater extends the range in all directions, allowing several floors to be covered.

Up to 6 repeaters can be registered to one Cell Station (CS) and up to 2 repeaters can be registered to one base unit. Also, up to 3 repeaters can be arranged in a cascade configuration.*1

*1 Cascade connections are not available when connecting with KX-TGP500 or KX-TGP550 base units.

Note

- You must register the repeater with your CS/base unit before it can be used.

System Connection Example

Example: Connecting CSs and PSs

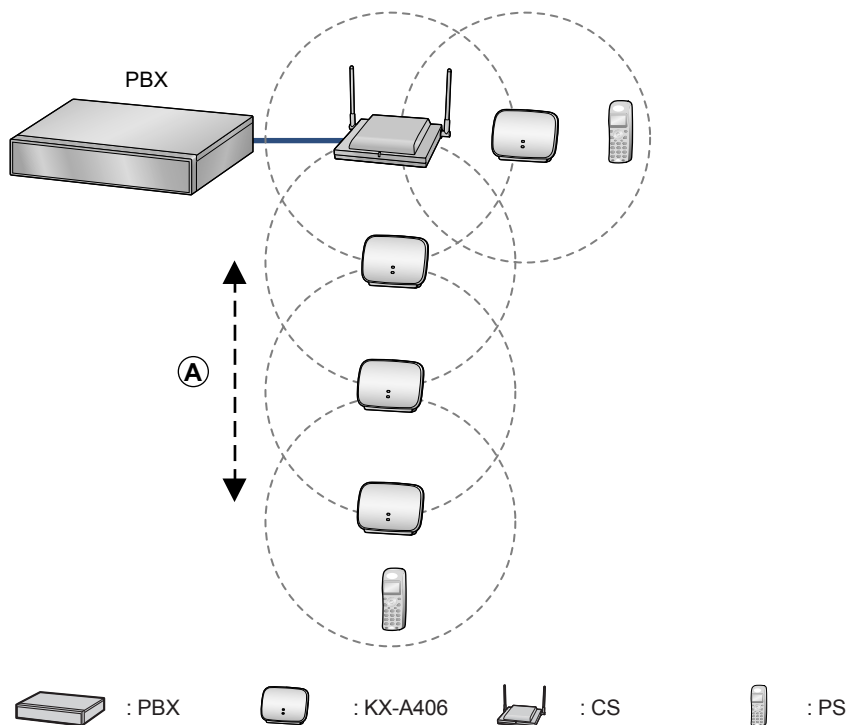

A: Cascade configuration

Overview

Repeater Coverage Area

As a guideline, the example below shows the size of the coverage area where one repeater can synchronize with a CS/base unit/destination repeater, or provide coverage for a PS/handset, if it is installed in an area with no obstacles.

Note

- The distance may vary depending on the environment.
- If the repeater's STATUS indicator and RSSI/ID indicator turn green (the radio signal strength level is strong) after turning on the repeater, the site is suitable for installing the repeater.

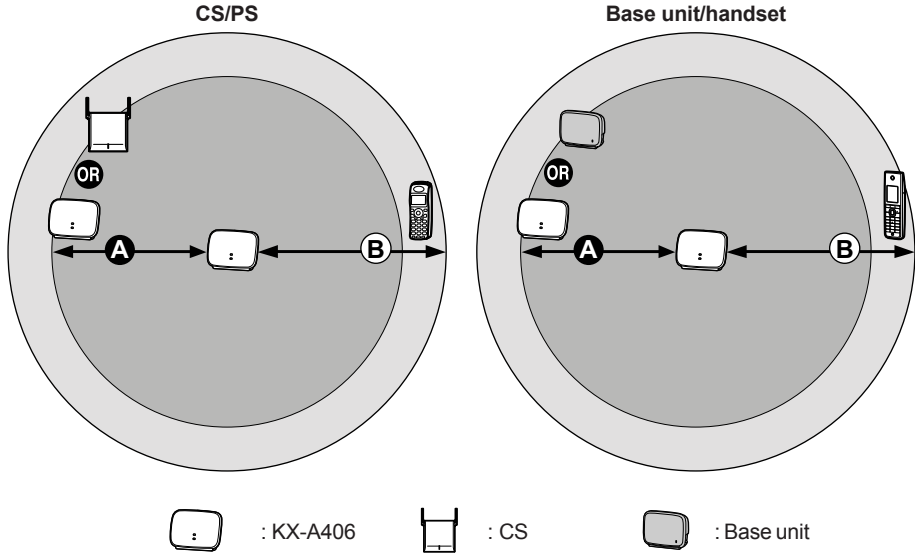

- A** Repeater coverage area for synchronization between CS/base unit/destination repeater and repeater.
Maximum Distance: 40 m to 50 m (98 ft to 131 ft)
- B** Repeater coverage area for PS/handset.
Maximum Distance: 50 m to 60 m (131 ft to 164 ft)

Location of Controls

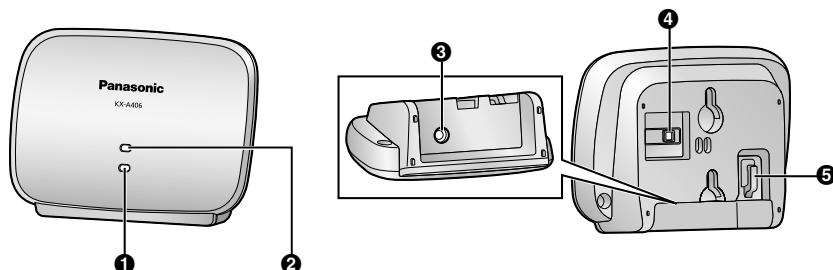

- 1** Ψ /ID RSSI/ID Indicator
 The RSSI (Received Signal Strength Indicator) shows the strength of the wireless network. Throughout this manual, the term "RSSI/ID" refers to Ψ /ID.
- 2** STATUS Indicator
- 3** DC Jack
- 4** PROGRAM Button
 Used to power off the repeater, or to switch to Operation Mode, ID Confirmation mode/Verification mode, Manual Registration mode, ID Modification Mode, De-registration Mode or Site Survey Mode.
- 5** Hook

Included Accessories

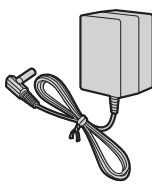
AC adaptor: 1	<table border="1"> <thead> <tr> <th>Model No.</th> <th>Part No.</th> </tr> </thead> <tbody> <tr> <td>KX-A406</td> <td>PQLV219</td> </tr> <tr> <td>KX-A406UK</td> <td>PQLV219E</td> </tr> <tr> <td>KX-A406CE</td> <td>PQLV219CE</td> </tr> <tr> <td>KX-A406AL</td> <td>PQLV219AL</td> </tr> <tr> <td>KX-A406LC</td> <td>PQLV219BX</td> </tr> <tr> <td>KX-A406LA</td> <td>PQLV219</td> </tr> </tbody> </table>	Model No.	Part No.	KX-A406	PQLV219	KX-A406UK	PQLV219E	KX-A406CE	PQLV219CE	KX-A406AL	PQLV219AL	KX-A406LC	PQLV219BX	KX-A406LA	PQLV219	Screws: 2 Washers: 2 
Model No.	Part No.															
KX-A406	PQLV219															
KX-A406UK	PQLV219E															
KX-A406CE	PQLV219CE															
KX-A406AL	PQLV219AL															
KX-A406LC	PQLV219BX															
KX-A406LA	PQLV219															

Note

For users in the United States only

To order accessories, call toll-free **1-800-322-5368**.

1. Linking to Cell Stations

Linking to Cell Stations

This section describes how to use the repeater to connect CSs and PSs.

Compatible Devices

The United States Only

Compatible Device	Model No.
CS	KX-T0155, KX-T0158, KX-TDA0156, KX-NCP0158, KX-NS0154

Canada Only

Compatible Device	Model No.
CS	KX-TDA0155, KX-TDA0156, KX-TDA0158, KX-NCP0158, KX-NS0154

Central and South America Only

Compatible Device	Model No.
CS	KX-TDA0155

All Other Countries/Areas

Compatible Device	Model No.
CS	KX-TDA0141, KX-TDA0142, KX-TDA0155, KX-TDA0156, KX-TDA0158, KX-NCP0158, KX-NS0154

Indicators

The indicator patterns and the corresponding status of the repeater in each mode are as follows. For details about each mode, refer to "Registering the Repeater" or "Using the Repeater".

Mode	Status	Indicators	
		STATUS	RSSI/ID
—	Power Off	Off	Off
De-registration Mode	Entering De-registration mode (0–5 seconds*1)	Red Flashing	Off
	Entering De-registration mode (5–10 seconds*1)	Quick Red Flashing	
	De-registration complete (after 10 seconds*1)	Red On	
Registration Mode (Easy/Manual)	Searching for devices	Red Flashing	Off

1. Linking to Cell Stations

Mode	Status	Indicators	
		STATUS	RSSI/ID
Operation Mode	Standby (signal is strong)	Green On	Green On
	Standby (signal is weak)		Amber On
	Standby (out of range)	Red On	Red On
	Talking (signal is strong)	Green Flashing	Green On
	Talking (signal is weak)		Amber On
	Busy (signal is strong)	Quick Green Flashing	Green On
	Busy (signal is weak)		Amber On
Manual Registration Mode	Entering Manual Registration Mode (after 5 seconds ^{*2})	Quick Green Flashing	Off
	ID1	Green On	1 Red Flash
	ID2		2 Red Flashes
	ID3		3 Red Flashes
	ID4		4 Red Flashes
	ID5		5 Red Flashes
	ID6		6 Red Flashes
	ID assigned		Red On
ID Modification Mode	Entering ID Modification Mode (after 5 seconds ^{*3})	Quick Amber Flashing	Off
	ID1	Amber On	1 Red Flash
	ID2		2 Red Flashes
	ID3		3 Red Flashes
	ID4		4 Red Flashes
	ID5		5 Red Flashes
	ID6		6 Red Flashes
	ID assigned		Red On
ID Confirmation/ Verification Tone Mode	ID1	Amber On	1 Green Flash
	ID2		2 Green Flashes
	ID3		3 Green Flashes
	ID4		4 Green Flashes
	ID5		5 Green Flashes
	ID6		6 Green Flashes

1. Linking to Cell Stations

Mode	Status	Indicators	
		STATUS	RSSI/ID
Site Survey Mode	Channel 1	1 Green Flash	Off
	Channel 2	2 Green Flashes	
	Channel 3	3 Green Flashes	
	Channel 4	4 Green Flashes	
	Channel 5	5 Green Flashes	
	Channel 6	6 Green Flashes	
	Channel 7	7 Green Flashes	
	Channel 8	8 Green Flashes	
	Channel 9	9 Green Flashes	
	Channel 0	10 Green Flashes	

- *1 The time elapsed after turning on the repeater while pressing and holding down the PROGRAM button.
- *2 The time elapsed after pressing and holding down the PROGRAM button in Operation mode.
- *3 The time elapsed after pressing and holding down the PROGRAM button in ID Confirmation/ Verification Tone mode.

Flashing Speeds

Indicators flash in a cycle at the following speeds:

Type of Flashing	Speed
Regular Flashing	640 ms On → 640 ms Off
Quick Flashing	320 ms On → 320 ms Off
1 Flash	Regular Flashing → 3 s Off
2 Flashes	Regular Flashing × 2 → 3 s Off
3 Flashes	Regular Flashing × 3 → 3 s Off
:	:

Procedure Overview

When registering and installing the repeater, follow the procedure below to ensure smooth operation.

Registering the Repeater

Note

- Register repeaters one by one. Do not register multiple repeaters simultaneously.
 - Do not disconnect the AC adaptor of any registered repeaters until the registration of all repeaters is complete.
 - After the registration of all repeaters is complete, proceed to the next step—"Installing the Repeater".
 - Use only the supplied Panasonic AC adaptor.
 - When connecting the AC adaptor to the repeater, press the plug firmly into the repeater for secure connection.
- a. Place the unregistered repeater(s) (including cascade configuration repeaters) near the CS you are attempting to register to.
- b. Turn on the repeater by connecting the AC adaptor.

c. When registering to a CS:

The repeater is automatically registered to the CS in Easy Registration mode. For details about the easy registration procedure, refer to "Easy Registration".

When creating a cascade configuration:

Each repeater in the cascade is automatically registered to the CS in Easy Registration mode when it is turned on.

Then, in Manual Registration mode, register each cascade repeater to its destination repeater. For details about the manual registration procedure, refer to "Manual Registration".

Installing the Repeater

- a. After all registration is complete, place the repeater where you want to install it.
- b. Turn on the repeater by connecting the AC adaptor.
The repeater enters Operation mode.
- If the STATUS indicator and the RSSI/ID indicator turn green (the radio signal strength level is strong), the site is suitable for installing the repeater.
 - If the RSSI/ID indicator turns amber or red (the radio signal strength level is weak or out of range), turn off the repeater by disconnecting the AC adaptor. Then, move the repeater closer to the CS/destination repeater, turn on the repeater again by connecting the AC adaptor, and confirm that the RSSI/ID indicator turns green.
- c. Check whether the PS can be used at any location within the coverage area required by the user. For details about conducting the site survey using a PS, refer to "Site Survey Mode".

1. Linking to Cell Stations

Registering the Repeater

Easy Registration

In easy registration, the repeater can be registered to a CS easily.

Note

- Easy registration cannot be performed if the repeater is already registered to another CS. In this case, de-register the repeater before attempting easy registration. For details about the de-registration procedure, refer to "De-registration".
- We recommend that you power down any CS that you do not wish to connect to the repeater prior to registration.

- 1 Turn on the repeater by connecting the AC adaptor.

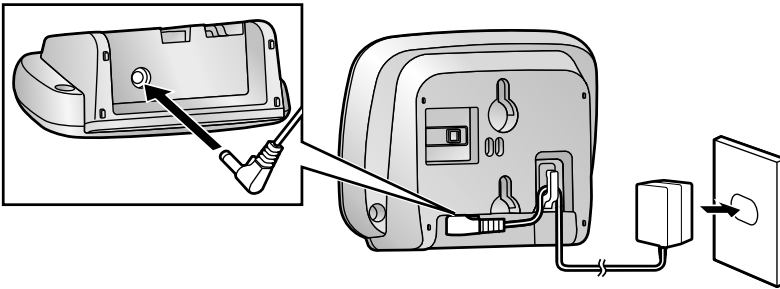

The STATUS indicator and the RSSI/ID indicator will turn amber for 2 seconds.

- 2 If the repeater is unregistered, the STATUS indicator will flash red, and the repeater automatically enters Easy Registration mode.
- 3 When the repeater has found a CS, the STATUS indicator will turn green. Registration is complete.

Manual Registration

In manual registration, the repeater can be registered to another repeater to create a cascade configuration.

Note

It is necessary to check the ID of the repeater you are attempting to register to (destination repeater) just before starting the manual registration.

- 1 Check the ID of the destination repeater.
 - a. In Operation mode, press the destination repeater's PROGRAM button to switch to ID Confirmation mode.
The ID is indicated by the number of times the RSSI/ID indicator flashes green.
 - b. Return the destination repeater to Operation mode by pressing the PROGRAM button again.

- 2 Turn on the repeater you want to register by connecting the AC adaptor.

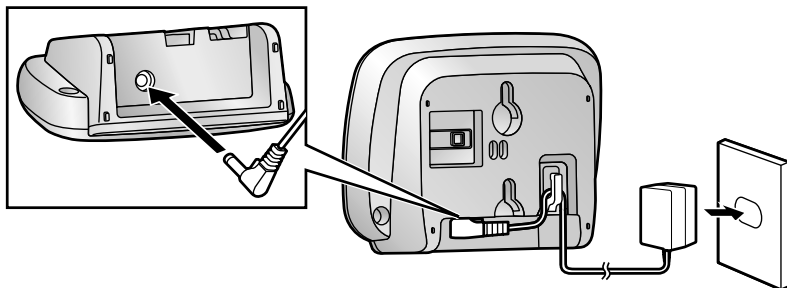

The STATUS indicator and the RSSI/ID indicator will turn amber for 2 seconds.

- 3 **When the repeater is unregistered:**

The STATUS indicator will flash red, and the repeater automatically enters Easy Registration mode.

- When the repeater is registered:**

The repeater automatically enters Operation mode.

- 4 Press and hold down the PROGRAM button for 5 seconds.
The STATUS indicator will flash green quickly.
- 5 Release the PROGRAM button to enter Manual Registration mode.
The STATUS indicator will turn green.
The RSSI/ID indicator will flash red once to indicate that the ID is currently set to 1.
- 6 If the ID of the destination repeater was not 1, press the PROGRAM button to select the ID that matches the destination repeater.
The ID will change by one each time the PROGRAM button is pressed. (e.g., If you select ID3 by pressing the button 2 times, the RSSI/ID indicator will flash 3 times.)
- 7 Press and hold down the PROGRAM button for 5 seconds to assign the ID to the repeater.
The RSSI/ID indicator will turn red.
- 8 Release the PROGRAM button to reset the repeater.
The STATUS indicator and the RSSI/ID indicator will turn amber for 2 seconds and then the STATUS indicator start flashing red. The repeater will then start searching for a repeater with the assigned ID.
- 9 When the repeater has found a repeater with the assigned ID, the STATUS indicator will turn green.
Registration is complete.

De-registration

Perform de-registration to delete the ID of the CS/repeater that the repeater is registered to.

- 1 While pressing and holding down the PROGRAM button (Page 11), turn on the repeater by connecting the AC adaptor.
- 2 Continue to hold down the PROGRAM button for 10 seconds.
When the STATUS indicator turns red, de-registration is complete.

Note

If the PROGRAM button is released after 5 seconds but before 10 seconds have elapsed, while the STATUS indicator is flashing red quickly, the repeater will enter Site Survey mode.

- 3 Release the PROGRAM button to reset the repeater.
The repeater automatically enters Easy Registration mode. For details about the easy registration procedure, refer to "Easy Registration".

1. Linking to Cell Stations

ID Modification

In ID Modification mode, the ID of the repeater (RPN [Radio Part Number]) can be selected. Registered repeaters are automatically assigned an ID during the registration process. This ID can be changed by following the procedure below.

- 1 In Operation mode, press the PROGRAM button to switch to ID Confirmation/Verification Tone mode. The STATUS indicator will turn amber.
- 2 Press and hold down the PROGRAM button for 5 seconds. The STATUS indicator will flash amber quickly.
- 3 Release the PROGRAM button to enter ID Modification mode. The STATUS indicator will turn amber. The RSSI/ID indicator will flash red once to indicate that the ID is currently set to 1.
- 4 Press the PROGRAM button to select the desired ID. The ID will change by one each time the PROGRAM button is pressed.
- 5 Press and hold down the PROGRAM button for 5 seconds to assign the ID to the repeater. The RSSI/ID indicator will turn red.
- 6 Release the PROGRAM button to reset the repeater. The STATUS indicator and the RSSI/ID indicator will turn amber for 2 seconds and then the repeater will return to Operation mode.

Using the Repeater

ID Confirmation/Verification Tone Mode

The ID of currently registered repeaters can be checked in ID Confirmation mode. Also, the coverage area of registered repeaters can be checked using a PS, in Verification Tone mode. When the beep is no longer heard, the PS is no longer in range of the repeater.

- 1 In Operation mode, press the PROGRAM button to switch to ID Confirmation/Verification Tone mode. The STATUS indicator will turn amber.
- 2 The current ID is indicated by the number of times the RSSI/ID indicator flashes green. At the same time, the verification tone will be activated, and the coverage of the repeater can be checked.

Note

If the repeater loses synchronization with the CS/destination repeater in ID Confirmation/Verification Tone mode, the repeater will automatically reset. After synchronization is established, the repeater will automatically enter ID Confirmation/Verification Tone mode again.

- 3 Return the repeater to Operation mode by pressing the PROGRAM button again. The verification tone will be deactivated.

Note

If you press and hold down the PROGRAM button for 5 seconds, the repeater will enter "ID Modification" mode.

Site Survey Mode

This function can be used to measure the transmission quality, and identify problematic transmission areas of the repeater installation. This function can be used when registered or de-registered.

Note

- The repeater's Site Survey mode works independently from the CS. This means that the CS does not have to be placed into Site Survey mode.
- When using more than 1 repeater in Site Survey mode simultaneously, please ensure repeaters are set to different channels.

- 1** While pressing and holding down the PROGRAM button, turn on the repeater by connecting the AC adaptor.
The STATUS indicator will flash red.
- 2** Continue to hold down the PROGRAM button for 5 seconds.
The STATUS indicator will flash red quickly.

Note

If you continue to hold down the PROGRAM button for 10 seconds, the repeater will enter De-registration mode.

- 3** Release the PROGRAM button.
The STATUS indicator will flash red to indicate the current channel number, and a carrier sense will start to check whether the current channel is available (idle) or not.
- 4** If the current channel is available, the STATUS indicator will change to flash green.
Site Survey mode on the current channel is now operational.

Note

A carrier sense is performed regularly in Site Survey mode. If the selected channel is not available (busy), the STATUS indicator will flash red to indicate the channel number and the repeater will stop transmitting.

- 5** Activate the site survey function on the PS to measure the radio signal strength level. The repeater CSID is 1234567890.

Note

- It is recommended that the radio signal strength level is "03" or greater.
- For details about using the PS during a site survey, refer to the appropriate documentation for the CS.

- 6** To change the site survey channel, press the PROGRAM button.
The channel number will change by one each time the PROGRAM button is pressed.
- 7** To turn off Site Survey mode, turn off the repeater by disconnecting the AC adaptor, and then turn on the repeater by connecting the AC adaptor.

Troubleshooting

PROBLEM	PROBABLE CAUSE	SOLUTION
<ul style="list-style-type: none">• The repeater does not turn on.	<ul style="list-style-type: none">• The AC adaptor is not connected properly.	<ul style="list-style-type: none">• Make sure that the AC adaptor is properly connected to both the repeater and the AC outlet.

1. Linking to Cell Stations

PROBLEM	PROBABLE CAUSE	SOLUTION
<ul style="list-style-type: none"> The repeater cannot be registered in Easy Registration mode. (The process keeps repeating automatically.) 	<ul style="list-style-type: none"> The CS is out of range. The CS is not turned on. 	<ul style="list-style-type: none"> Move the repeater closer to the CS. Confirm that the CS is on.
<ul style="list-style-type: none"> The repeater cannot be registered in Manual Registration mode. (The process keeps repeating automatically.) 	<ul style="list-style-type: none"> The destination repeater is not turned on. The selected ID does not match the ID of the destination repeater. 	<ul style="list-style-type: none"> Confirm that the destination repeater is on. Follow the procedure below to change the selected ID. <ol style="list-style-type: none"> Check the ID of the destination repeater in ID Confirmation mode (refer to "ID Confirmation/Verification Tone Mode"). Enter Manual Registration mode by pressing and holding down the PROGRAM button of the repeater for 5 seconds while the repeater's STATUS indicator is flashing red, and releasing it. Select the ID that matches the destination repeater in manual registration again (refer to "Manual Registration").
<ul style="list-style-type: none"> The repeater's STATUS indicator and RSSI/ID indicator flash green and red alternately (alarm indication). 	<ul style="list-style-type: none"> The ID of the repeater is the same as the ID of another repeater (including cascade configuration repeaters) that is registered to the same CS. 	<ul style="list-style-type: none"> Follow the procedure below to change the ID of the repeater. <ol style="list-style-type: none"> Press the PROGRAM button to cancel the alarm indication of the repeater. The repeater will enter ID Confirmation mode. Check the IDs of the repeater and the other repeater that is registered to the same CS, in ID Confirmation mode (refer to "ID Confirmation/Verification Tone Mode"). Enter ID Modification mode by pressing and holding down the PROGRAM button of the repeater for 5 seconds and releasing it. Change the ID of the repeater so as not to overlap with the ID of the other repeater in ID Modification mode (refer to "ID Modification").
<ul style="list-style-type: none"> The PS is beeping. 	<ul style="list-style-type: none"> The verification tone is turned on. 	<ul style="list-style-type: none"> Turn the verification tone off (refer to "ID Confirmation/Verification Tone Mode").
<ul style="list-style-type: none"> Poor audio quality. 	<ul style="list-style-type: none"> The CS is out of range. The PS is out of range. 	<ul style="list-style-type: none"> Move the repeater closer to the CS. Move the PS closer to the repeater.

1. Linking to Cell Stations

PROBLEM	PROBABLE CAUSE	SOLUTION
● A ringing call suddenly stops when moving between CS/repeater zones.	● There is a delay when moving from a CS zone to a repeater zone when receiving a call in group ring mode.	● Answer the call before moving between CS/repeater zones.
● When talking and moving between zones, you hear an alarm or continuous noise, or your call is disconnected.	● The new zone is "busy", so handover cannot occur.	● Return to the original zone and continue your call.

Linking to SIP Cordless Phones

This section describes how to use the repeater to connect SIP cordless phone base units and handsets.

Compatible Devices

The United States, Canada, Central and South America

Compatible Device	Model No.
Base unit	KX-TGP600

All Other Countries/Areas

Compatible Device	Model No.
Base unit	KX-TGP500, KX-TGP550, KX-TGP600

Indicators

Indicators	Light Status		Meaning
STATUS	Green	On	● Within base unit range. The repeater is ready for use.
		Flashing	● 1 handset is communicating with the base unit through the repeater.
		Quick Flashing	● 2 handsets are communicating with the base unit through the repeater.
	Red	On	● Out of base unit range.
		Flashing	● The repeater is not registered to the base unit.
Off		● The power is off. (AC adaptor is not connected properly.)	
RSSI/ID	Green	On	● Signal strength of the base unit is strong.
		Flashing	● The number of times the RSSI/ID indicator flashes indicates the current ID of registered repeaters. When it flashes green once, it indicates that the ID is currently set to 1. ● The base unit is in repeater range.
	Amber	On	● Signal strength of the base unit is weak.
	Red	On	● Out of base unit range. ● The ID has been registered to the repeater.
		Flashing	● The number of times the RSSI/ID indicator flashes indicates the ID that will be registered to the repeater. When it flashes red once, it indicates that the ID will be set to 1.
	Off		● The repeater is not being used. ● The power is off.

Installation/Registering the Repeater

Once the repeater is connected to an AC outlet, it automatically goes into registration mode (if not already registered).

IMPORTANT

- Before registering the repeater to the base unit, you must turn the repeater mode on. Refer to the appropriate documentation for the base unit.
- If the repeater is already registered, deregister the repeater first, then re-register it. For registering and deregistering the repeater, refer to "Deregister" and "Re-register" in "Troubleshooting".

Note

- Use only the supplied Panasonic AC adaptor.
- When connecting the AC adaptor to the repeater, press the plug firmly into the repeater for secure connection.

1 Repeater: Connect the AC adaptor.

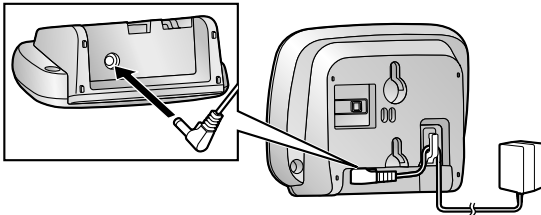

2 Base unit: Press and hold the Handset locator button for about 4 seconds until the STATUS indicator flashes red.

- The button and indicator depend on the base unit.
- If all registered handsets start ringing, press the same button to stop. Then repeat this step.
- The next step must be completed within 90 seconds.

3 Repeater: Connect the AC adaptor to an AC outlet.

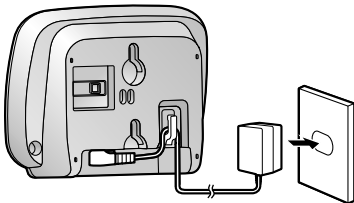

- When the repeater is turned on, the STATUS indicator and RSSI/ID indicator turn amber for about 2 seconds.

4 Repeater: Wait until the STATUS indicator and RSSI/ID indicator turn green. (The repeater is ready for use.)

- If the indicators do not turn green, re-position the repeater in a place where the indicators turn green.

5 Base unit: To exit registration mode, press the Handset locator button.

- The button depends on the base unit.

2. Linking to SIP Cordless Phones

Note

- The AC adaptor must remain connected at all times. (It is normal for the adaptor to feel warm during use.)
- The repeater can support a maximum of 4 calls at a time.
- When the STATUS indicator flashes green rapidly, a handset registered to the repeater cannot make/receive a call through the repeater. Neither can a handset during a conversation within the base unit range switch to the repeater range.
- Do not use more than 2 repeaters at a time.
- Cascade connections are not available when connecting with KX-TGP500 or KX-TGP550 base units.
- The following limitations apply when the KX-A406 (repeater) is connected to a KX-TGP600 base unit.
 - Narrowband mode:
Up to 3 KX-A406 units can be connected in a cascade configuration, and up to 4 calls can be made simultaneously.
 - Wideband mode:
Up to 2 KX-A406 units can be connected in a cascade configuration, and up to 2 calls can be made simultaneously.

Troubleshooting

Problem	Cause/solution
The repeater does not work.	<ul style="list-style-type: none">● When the indicators do not turn on, the AC adaptor is not connected properly. Check the connections.● When the indicators do not turn green, move the repeater closer to the base unit.● Registration may have been canceled. Deregister the repeater, then re-register. <p>Deregister</p> <ol style="list-style-type: none">1 Unplug the AC adaptor, then press and hold the PROGRAM button.2 While pressing and holding the PROGRAM button, re-connect the AC adaptor.3 Keep pressing and holding the PROGRAM button for about 10 seconds until the STATUS indicator stops flashing and RSSI/ID indicator turns red. Then release the PROGRAM button. <ul style="list-style-type: none">● The STATUS indicator and the RSSI/ID indicator turn amber for about 2 seconds and the STATUS indicator flashes red again.● If the STATUS indicator flashes green after releasing the PROGRAM button, deregistration failed. Deregister the repeater again. <p>Re-register</p> <p>Unplug the AC adaptor, then perform from step 2 of "Installation/Registering the Repeater".</p>
While talking using the handset, sound cuts in and out.	<ul style="list-style-type: none">● The handset is out of range. Move the handset closer to the repeater.

2. Linking to SIP Cordless Phones

Problem	Cause/solution
<p>A repeating tone is heard while talking using the handset. or The STATUS indicator is amber and the RSSI/ID indicator flashes green.</p>	<ul style="list-style-type: none"> ● The PROGRAM button was pressed. The repeater is in programming mode. To exit, press the PROGRAM button again. Do not press the PROGRAM button, except when deregistering the repeater.
<p>The repeater's STATUS indicator and RSSI/ID indicator flash green and red alternately (alarm indication).</p>	<ul style="list-style-type: none"> ● The ID of the repeater is the same as the ID of another repeater that is registered to the same base unit. Deregister both of the repeaters, then re-register them near the base unit. <p>Deregister</p> <ol style="list-style-type: none"> 1 Unplug the AC adaptor, then press and hold the PROGRAM button. 2 While pressing and holding the PROGRAM button, re-connect the AC adaptor. 3 Keep pressing and holding the PROGRAM button for about 10 seconds until the STATUS indicator stops flashing and RSSI/ID indicator turns red. Then release the PROGRAM button. <ul style="list-style-type: none"> ● The STATUS indicator and the RSSI/ID indicator turn amber for about 2 seconds and the STATUS indicator flashes red again. ● If the STATUS indicator flashes green after releasing the PROGRAM button, deregistration failed. Deregister the repeater again. <p>Re-register</p> <p>Unplug the AC adaptor, then perform from step 2 of "Installation/Registering the Repeater".</p>
<p>The handset registered to the repeater cannot make/receive a call.</p>	<ul style="list-style-type: none"> ● When the STATUS indicator flashes green rapidly, a handset registered to the repeater cannot make/receive a call through the repeater. Move closer to the base unit or wait until the STATUS indicator flashes slowly or the STATUS indicator is on.

Linking to Digital Cordless Phones (except for North America)

This section describes how to use the repeater to connect Panasonic Digital Cordless Phone base units and handsets.

Indicators

Indicators	Light Status		Meaning
STATUS	Green	On	● Within base unit range. The repeater is ready for use.
		Flashing	● Handsets are communicating with the base unit through the repeater.
	Red	On	● Out of base unit range.
		Flashing	● The repeater is not registered to the base unit.
	Off		● The power is off. (AC adaptor is not connected properly.)
RSSI/ID	Green	On	● Signal strength of the base unit is strong.
	Amber	On	● Signal strength of the base unit is weak.
	Red	On	● Out of base unit range.
	Off		● The repeater is not being used. ● The power is off.

Installation/Registering the Repeater

Once the repeater is connected to an AC outlet, it automatically goes into registration mode (if not already registered).

IMPORTANT

- If the repeater is already registered, deregister the repeater first, then re-register it. For registering and deregistering the repeater, refer to "Deregister" and "Re-register" in "Troubleshooting".

Note

- Use only the supplied Panasonic AC adaptor.
- When connecting the AC adaptor to the repeater, press the plug firmly into the repeater for secure connection.

1 Repeater: Connect the AC adaptor.

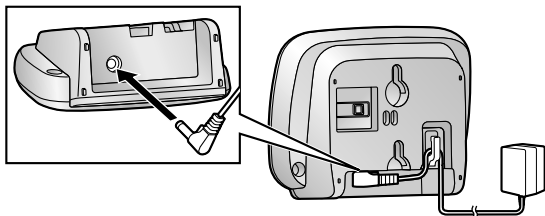

2 Base unit: Press and hold the Handset locator button for about 5 seconds.

- If all registered handsets start ringing, press the same button to stop. Then repeat this step.
- The next step must be completed within 90 seconds.

3 Repeater: Connect the AC adaptor to an AC outlet.

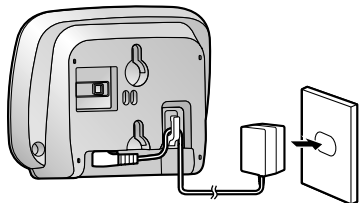

- When the repeater is turned on, the STATUS indicator and RSSI/ID indicator turn amber for about 2 seconds.

4 Repeater: Wait until the STATUS indicator and RSSI/ID indicator turn green. (The repeater is ready for use.)

- If the indicators do not turn green, re-position the repeater in a place where the indicators turn green.

5 Base unit: To exit registration mode, press the Handset locator button.

- The button depends on the base unit.

Note

- The AC adaptor must remain connected at all times. (It is normal for the adaptor to feel warm during use.)
- The repeater can support a maximum of 4 calls at a time.
- Do not use more than 2 repeaters at a time.

Troubleshooting

Problem	Cause/solution
The repeater does not work.	<ul style="list-style-type: none">● When the indicators do not turn on, the AC adaptor is not connected properly. Check the connections.● When the indicators do not turn green, move the repeater closer to the base unit.● Registration may have been canceled. Deregister the repeater, then re-register. <p>Deregister</p> <ol style="list-style-type: none">1 Unplug the AC adaptor, then press and hold the PROGRAM button.2 While pressing and holding the PROGRAM button, re-connect the AC adaptor.3 Keep pressing and holding the PROGRAM button for about 10 seconds until the STATUS indicator stops flashing and RSSI/ID indicator turns red. Then release the PROGRAM button. <ul style="list-style-type: none">● The STATUS indicator and the RSSI/ID indicator turn amber for about 2 seconds and the STATUS indicator flashes red again.● If the STATUS indicator flashes green after releasing the PROGRAM button, deregistration failed. Deregister the repeater again. <p>Re-register</p> <p>Unplug the AC adaptor, then perform from step 2 of "Installation/Registering the Repeater".</p>
While talking using the handset, sound cuts in and out.	<ul style="list-style-type: none">● The handset is out of range. Move the handset closer to the repeater.
A repeating tone is heard while talking using the handset. or The STATUS indicator is amber and the RSSI/ID indicator flashes green.	<ul style="list-style-type: none">● The PROGRAM button was pressed. The repeater is in programming mode. To exit, press the PROGRAM button again. Do not press the PROGRAM button, except when deregistering the repeater.

Appendix

This section describes about mounting the repeater on a wall and its specifications.

Wall Mounting

Mounting

CAUTION

- Make sure the cable is securely fastened to the wall.

- 1 Place the reference for wall mounting on the wall to mark the 2 screw positions.
- 2 Install the 2 screws and washers (included) into the wall.

Note

- Make sure that the screw heads are at the same distance from the wall.
 - Install the screws perpendicular to the wall.
- 3 Hook the repeater on the screw heads.

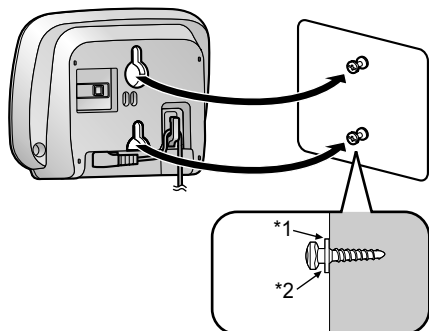

*1 Washer

*2 Drive the screw to this point.

Appendix

Reference for Wall Mounting

Print this page and use as a reference for wall mounting.

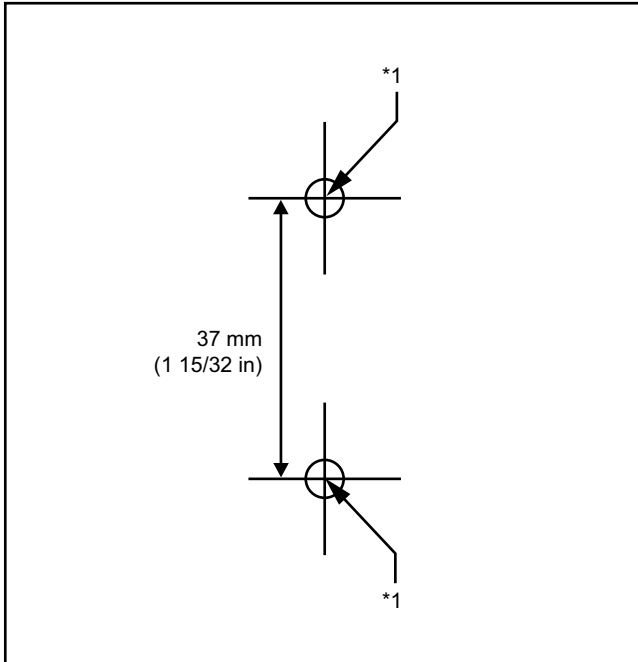

*1 Install a screw here.

Note

Make sure to set the print size to correspond with the size of this page. If the dimension of the paper output still deviates slightly from the measurement indicated here, use the measurement indicated here.

Specifications

Basic Specifications

Maximum Number of Simultaneous Calls	4*1
Maximum Number of Cascade Steps	3*2
Maximum Number of Repeaters Registered to a CS/base unit	6*3

- *1 The maximum number of simultaneous calls is 2 when connecting with KX-TGP500 or KX-TGP550 base units, or using wideband audio codec G.722 or G.722.2.
- *2 Cascade connections are not available when connecting with KX-TGP500 or KX-TGP550 base units.
- *3 The maximum number of repeaters is 2 when connecting with KX-TGP500 or KX-TGP550 base units.

Note

The maximum number of simultaneous calls may decrease depending on the wireless environment or the PBX's system configuration.

General Specifications

Dimensions (Width × Depth × Height)	111 mm (W) × 39 mm (D) × 82 mm (H) (4 3/8 in × 1 1/2 in × 3 1/4 in)
Weight	88 g (3.1 oz)
Power Supply	AC Adaptor Input: KX-A406/KX-A406LA AC 100 V–120 V, 60 Hz KX-A406CE/KX-A406UK/KX-A406AL/KX-A406LC AC 220 V–240 V, 50 Hz/60 Hz Output: DC 6.5 V, 500 mA
Operating Temperature	0 °C to 40 °C (32 °F to 104 °F)

RF Specifications

Wireless Interface	DECT/DECT 6.0*1
Radio Access Method	MultiCarrier TDMA-TDD
Frequency Band	KX-A406CE/KX-A406UK/KX-A406AL 1880 MHz to 1900 MHz KX-A406LC/KX-A406LA 1910 MHz to 1920 MHz KX-A406 1920 MHz to 1930 MHz
Number of Carriers	KX-A406CE/KX-A406UK/KX-A406AL 10 KX-A406/KX-A406LA/KX-A406LC 5

Appendix

Carrier Spacing	1728 kHz
Bit Rate	1152 kbps
Modulation Scheme	GFSK
Transmission Output	KX-A406 Peak 115 mW KX-A406CE/KX-A406UK/KX-A406AL/KX-A406LC/ KX-A406LA Peak 250 mW

*1 The wireless interface differs according to the country/area.

Panasonic System Networks Co., Ltd.

1-62, 4-chome, Minoshima, Hakata-ku, Fukuoka 812-8531, Japan

<http://www.panasonic.net/>

Panasonic Corporation of North America

Two Riverfront Plaza, Newark, NJ 07102-5490

<http://www.panasonic.com/bts>

Panasonic Canada Inc.

5770 Ambler Drive, Mississauga, Ontario L4W 2T3

<http://www.panasonic.ca>

Copyright:

This material is copyrighted by Panasonic System Networks Co., Ltd., and may be reproduced for internal use only. All other reproduction, in whole or in part, is prohibited without the written consent of Panasonic System Networks Co., Ltd.