

DynaDish 5

The DynaDish 5 is a new 802.11ac outdoor device with an integrated antenna. Compact in its design, it is a simple and completely integrated product with everything you need to quickly install a reliable point to point link.

The DynaDish 5 is powered by a new 720 MHz CPU from Qualcomm.

New 802.11ac outdoor device

- ideal for long distance point-to-point links
- 5 GHz dual chain board integrated into 25 dBi dish antenna with 8 degree beam width
- 720 Mhz CPU 300 MHz DDR2
- one Gigabit Ethernet port

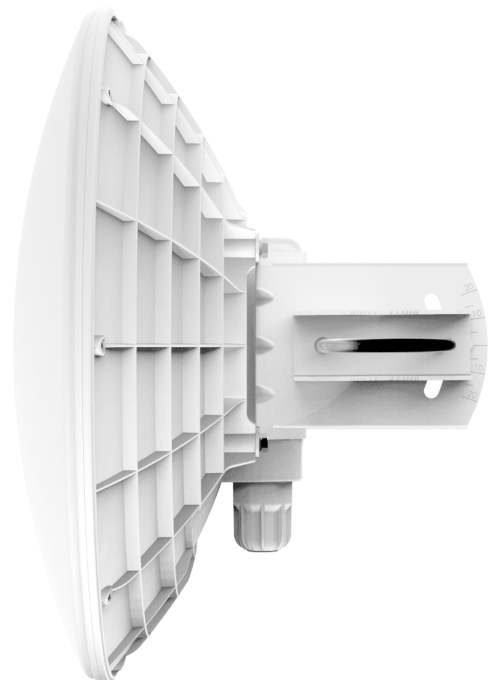

The antenna is a 8 degree 25 dBi dish, and it includes a precise alignment mount, ideal for long range point to point wireless links.

Specifications

Product code	RBDynaDishG-5HacD
CPU	QCA9557 720 MHz
Size of RAM	128 MB
10/100/1000 Ethernet ports	1
Wireless	Built-in 5 GHz 802.11ac, dual-chain
Frequency range	4920 - 6100 MHz (Operating range limited by Country Regulations)
Antenna gain	25 dBi
Antenna beam width	8°
Wireless chip model	QCA9892
Port to port isolation	23 db
Return loss	< 15 db
VSWR	1.5
PoE in	Yes
Supported input voltage	11V - 60V passive PoE or 802.3af/at with unshielded cable
Voltage Monitor	Yes
PCB temperature monitor	Yes
CPU temperature monitor	No
Dimensions	Ø 404 mm, height 175 mm (without mount)
License level	3
Operating System	RouterOS
Max Power consumption	16 W
Supported channels	20/40/80 MHz

Included



24V 0.8A Power adapter

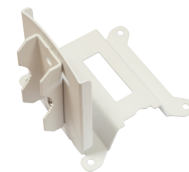

Precision mount



U Kit



Gigabit PoE injector

Wireless specifications

RATE	Tx (dBm)	Rx (dBm)
6MBit/s	31	-96
54MBit/s	28	-81
MCS0	30	-96
MCS7	27	-77
MCS9	22	-72

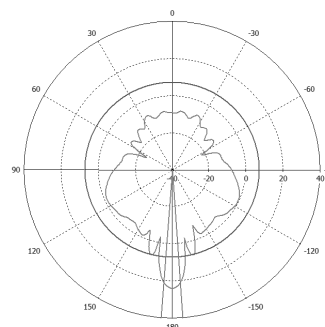

Horizontal polarization

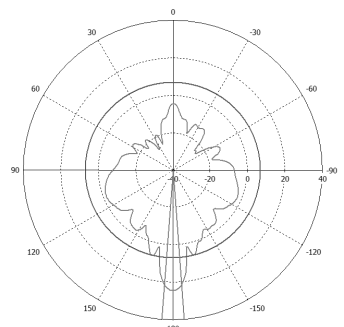

Vertical polarization