



370111

Cisco RV320/RV325 Gigabit Dual WAN VPN Router

Package Contents

- Cisco RV320/RV325 Gigabit Dual WAN VPN Router
- Ethernet Cable
- Power Adapter
- Quick Start Guide
- Documentation and software on CD-ROM

Versión en Español para México en el CD
Version en français sur CD
Versione italiana sul CD
Deutsch Version auf CD
日本語バージョン CD

Welcome

Thank you for choosing the Cisco RV320/RV325 Gigabit Dual WAN VPN Router.

This guide describes how to physically install your Cisco RV320/RV325 and launch the web-based Device Manager.

1

Installing Cisco RV320/RV325

To prevent the device from overheating or being damaged:

- **Ambient Temperature**—Do not operate it in an area that exceeds an ambient temperature of 104°F (40°C).
- **Air Flow**—Be sure that there is adequate air flow around the device. If wall mounting the firewall, make sure the heat dissipation holes are to the side.
- **Circuit Overloading**—Adding the device to the power outlet must not overload that circuit.
- **Mechanical Loading**—Be sure that the device is level and stable to avoid any hazardous conditions and that it is secure to prevent it from sliding or shifting out of position. Do not place anything on top of the firewall, as excessive weight might damage it.

For desktop mounting, place the device on a flat surface so that it sits on its four rubber feet.

Wall Mounting

The router has two wall-mount slots on the bottom panel. To mount the router on a wall, you need mounting hardware (not included). Suggested hardware is illustrated below (not true to scale).

RV320

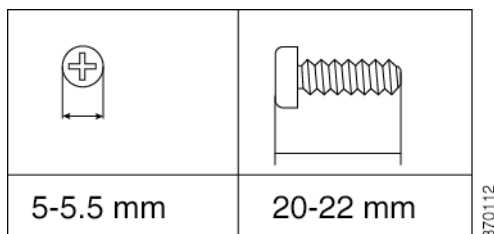

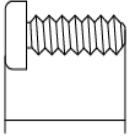
	
6.5-7 mm	16.5-18.5 mm

370020

 **WARNING** Insecure mounting might damage the router or cause injury. Cisco is not responsible for damages incurred by insecure wall-mounting.

 **WARNING** For safety, ensure that the heat dissipation holes are facing sideways.

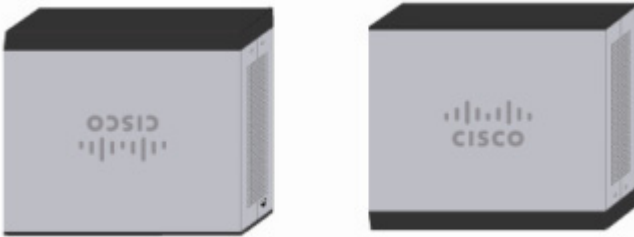

- STEP 1** Drill two pilot holes, approximately 109 mm apart, into the surface.
- STEP 2** Insert a screw into each hole, leaving a gap between the surface and the base of the screw head of 1 to 1.2 mm.
- STEP 3** Place the router wall-mount slots over the screws and slide the router down until the screws fit snugly into the wall-mount slots.

Rack Mounting Cisco RV325

Your Cisco RV325 device includes a rack-mount kit that contains:

- Two rack-mount brackets, 121 mm x 50mm x 44mm in size.
- Eight M4 x 0.7p x 6mm screws.

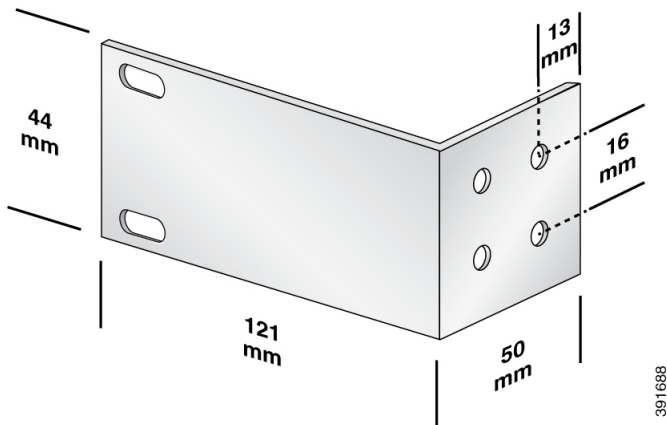

2

Cisco RV320 Features

Front Panel

PWR—Lit to indicate the unit is powered on and booted. Blinks when the device is booting.

VPN—Lit green when the designated VPN tunnel is up. Blinks green when data is being sent or received through the tunnel. Lit amber when the tunnel is disconnected. Blinks amber when attempting to establish the tunnel.

DMZ—Lit green when the DMZ/WAN port is configured as a DMZ.

DIAG—Blinks red when the firmware is updating. Lit red when the device is booting.

LINK/ACT—Lit steady when a link between a port and another device is detected. Flashes when a port is passing traffic.

GIGABIT—Lit when another device is connected to a port and a 1000 Mbps link is established. Off when the connection speed is under 1000 Mbps or no other device is attached to a port.

LAN 1-4—Lit when the LAN ports on the back panel are linked to another device. Blinks when passing traffic.

DMZ/WAN—Lit when a device is connected to the DMZ/WAN port. Flashes when sending or receiving data over the WAN DMZ port.

WAN—Lit when the WAN port is connected. The light is off when it is not connected to the Internet or it is connected by using a USB dongle. Blinks when it is sending or receiving data over the WAN connection.

USB 1 and **USB 2**—Lit green when the corresponding port is connected to a device. Flashes green when the port is sending or receiving data.

RESET—Reboot or reboot and restore defaults:

- To reboot the unit and retain the current configuration, press and hold **RESET** for at least 3, but no more than 10 seconds, by using a paper clip or a pen tip.
- To reboot the unit and restore the factory default configuration, press and hold in the **RESET** button for more than 10 seconds. Changes you have made to the configuration of your device are lost.

Back Panel

POWER—Toggles power to the device on or off.

12VDC (1.5A)—Power port that connects the device to the provided 12VDC, 1.5 amp power adapter.

LAN (1-4)—RJ-45 connectors that link local area network devices, such as PCs, print servers, or switches, to the device.

DMZ/WAN—Internet device connection supporting a DMZ for connecting the device to a wide area network device, such as a cable or DSL modem.

WAN—Internet connection for connecting the device to a wide area network device, such as a cable or DSL modem.

USB 1—Type A USB port that supports flash drives and 3G/4G/LTE USB dongles. Caution: Use only the power supply provided with the device; using another power supply might cause the USB dongle to fail.

Side Panel

USB 2—Type A USB port that supports flash drives and 3G/4G/LTE USB dongles. Caution: Use only the power supply provided with the device; using another power supply might cause the USB dongle to fail.

Front Panel

PWR—Lit to indicate the unit is powered on and booted. Blinks when the device is booting.

VPN—Lit green when the designated VPN tunnel is up. Blinks green when data is being sent or received through the tunnel. Lit amber when the tunnel is disconnected. Blinks amber when attempting to establish the tunnel.

DMZ—Lit green when the DMZ/WAN port is configured as a DMZ.

DIAG—Blinks red when the firmware is updating. Lit red when the device is booting.

USB 1 and **USB 2**—Lit green when the corresponding port is connected to a device. Flashes green when the port is sending or receiving data.

LAN 1-14—RJ-45 connectors that link local area network devices, such as PCs, print servers, or switches, to the device.

WAN—Lit when the WAN port is connected. The light is off when it is not connected to the Internet or it is connected by using a USB dongle. Blinks when it is sending or receiving data over the WAN connection.

DMZ/WAN—Lit when a device is connected to the DMZ/WAN port. Flashes when sending or receiving data over the WAN DMZ port.

LINK/ACT—Lit steady when a link between a port and another device is detected. Flashes when a port is passing traffic.

GIGABIT—Lit when another device is connected a port and a 1000 Mbps link is established. Off when the connection speed is under 1000 Mbps or no other device is attached to a port.

USB 1—Type A USB port that supports flash drives and 3G/4G/LTE USB dongles. Caution: Use only the power supply provided with the device; using another power supply might cause the USB dongle to fail.

RESET—Reboot or reboot and restore defaults:

- To reboot the unit and retain the current configuration, press and hold **RESET** for at least 3, but no more than 10 seconds, by using a paper clip or a pen tip.
- To reboot the unit and restore the factory default configuration, press and hold in the **RESET** button for more than 10 seconds. Changes you have made to the configuration of your device are lost.

Back Panel

POWER—Toggles power to the device on or off.

12VDC (2A)—Power port that connects the device to the provided 12VDC, 2 amp power adapter.

Side Panel

USB 2—Type A USB port that supports flash drives and 3G/4G/LTE USB dongles. Caution: Use only the power supply provided with the device; using another power supply might cause the USB dongle to fail.

4

Connecting

You must connect a configuration terminal (PC) to the device by using a LAN port. The terminal must be in the same wired subnetwork as the device to perform the initial configuration. As part of the initial configuration, the device can be configured to allow remote management.

To connect a computer to the device:

-
- STEP 1** Power off all equipment, including the cable or DSL modem, the computer, and this device.
 - STEP 2** Use an Ethernet cable to connect your cable or DSL modem to the WAN port on this device.
 - STEP 3** Connect another Ethernet cable from one of the LAN (Ethernet) ports to the Ethernet port on the computer.
 - STEP 4** Power on the WAN device and wait until the connection is active.
 - STEP 5** Connect the power adapter to the 12VDC port of this device.



CAUTION

Use only the power adapter that is supplied with the device. Using a different power adapter could damage the device or cause the USB dongles to fail.

The **POWER** switch is on by default. The power light on the front panel is lit when the power adapter is connected properly and the device is finished booting.

- STEP 6** Plug the other end of the adapter into an electrical outlet. Use the plug (supplied) specific to your country.
 - STEP 7** Power on the computer that you connected to the LAN port in **Step 3**. Your computer becomes a DHCP client of the device and receives an IP address in the 192.168.1.xxx range.
-

Logging In

To log into the device:

STEP 1 Launch a web browser.

STEP 2 In the address bar, enter the default IP address of the device, **https://192.168.1.1**. A site security certificate message is displayed. The Cisco RV320/RV325 uses a self-signed security certificate. This message appears because the device is not known to your computer.

STEP 3 Click **Continue to this website** (or the option shown on your particular web browser) to continue. The login displays.

STEP 4 Enter the username and password. The default username is **cisco**. The default password is **cisco**. Passwords are case sensitive.

STEP 5 Click **Log In**. The Device Manager application starts.

We recommend that you change the password. You are required to change the password before enabling features such as remote management.

Changing the Administrator Username and Password

To change the Administrator username and password on the device:

STEP 1 From the Getting Started page, select **Change Administrator Password** or select **Setup > Password** from the navigation bar.

STEP 2 Change the **Username**.

STEP 3 Enter the **Old Password**.

STEP 4 Enter the **New Password**.

STEP 5 **Confirm** the **New Password**.

STEP 6 Click **Save**.

Troubleshoot Your Connection

If you cannot access your device by using Device Manager, the device might not be reachable from your computer. You can test network connections by using **ping** on a computer running Windows:

STEP 1 Open a command window by using **Start > Run** and enter **cmd**.

STEP 2 At the **Command** window prompt, enter **ping** and the device IP address. For example, **ping 192.168.1.1** (the default static IP address of the device).

If you can reach the device, you should get a reply similar to the following:

```
Pinging 192.168.1.1 with 32 bytes of data:  
Reply from 192.168.1.1: bytes=32 time<1ms TTL=128
```

If you cannot reach the device, you should get a reply similar to the following:

```
Pinging 192.168.1.1 with 32 bytes of data:  
Request timed out.
```

Possible Causes and Resolutions

Bad Ethernet connection:

Check the LEDs for the proper indications. Check the connectors of the Ethernet cable to ensure they are firmly plugged into the device and your computer.

Wrong or conflicting IP address:

Verify that you are using the correct IP address of the device.

Verify that no other device is using the same IP address as this device.

No IP route:

If the device and your computer are in different IP subnetworks, remote access must be enabled and you need at least one router on the network to route the packets between the two subnetworks.

Unusually long access time:

Adding new connections might take 30 to 60 seconds for the affected interfaces and/or LAN to become operational.

5

Where to Go From Here

Support	
Cisco Support Community	www.cisco.com/go/smallbizsupport
Cisco Support and Resources	www.cisco.com/go/smallbizhelp
Phone Support Contacts	www.cisco.com/en/US/support/tsd_cisco_small_business_support_center_contacts.html
Cisco Firmware Downloads	www.cisco.com/cisco/software/navigator.html?i=!ch Select a link to download firmware for Cisco Products. No login is required.
Product Documentation	
Cisco Routers and Firewalls	www.cisco.com/go/smallbizrouters
Additional Resources	
Cisco Partner Central (Partner Login Required)	www.cisco.com/web/partners/sell/smb
Cisco Home	www.cisco.com/smb
EU Lot 26 Related Test Results	www.cisco.com/go/eu-lot26-results

Americas Headquarters

Cisco Systems, Inc.
170 West Tasman Drive
San Jose, CA 95134-1706 USA

www.cisco.com
www.cisco.com/go/sbsc



78-20927-04

Cisco and the Cisco logo are trademarks or registered trademarks of Cisco and/or its affiliates in the U.S. and other countries. To view a list of Cisco trademarks, go to this URL: www.cisco.com/go/trademarks. Third-party trademarks mentioned are the property of their respective owners. The use of the word partner does not imply a partnership relationship between Cisco and any other company. (1110R)

© 2014 Cisco Systems, Inc. All rights reserved.